

MODEL N150KE

N150KE-dims (04-02-2014)

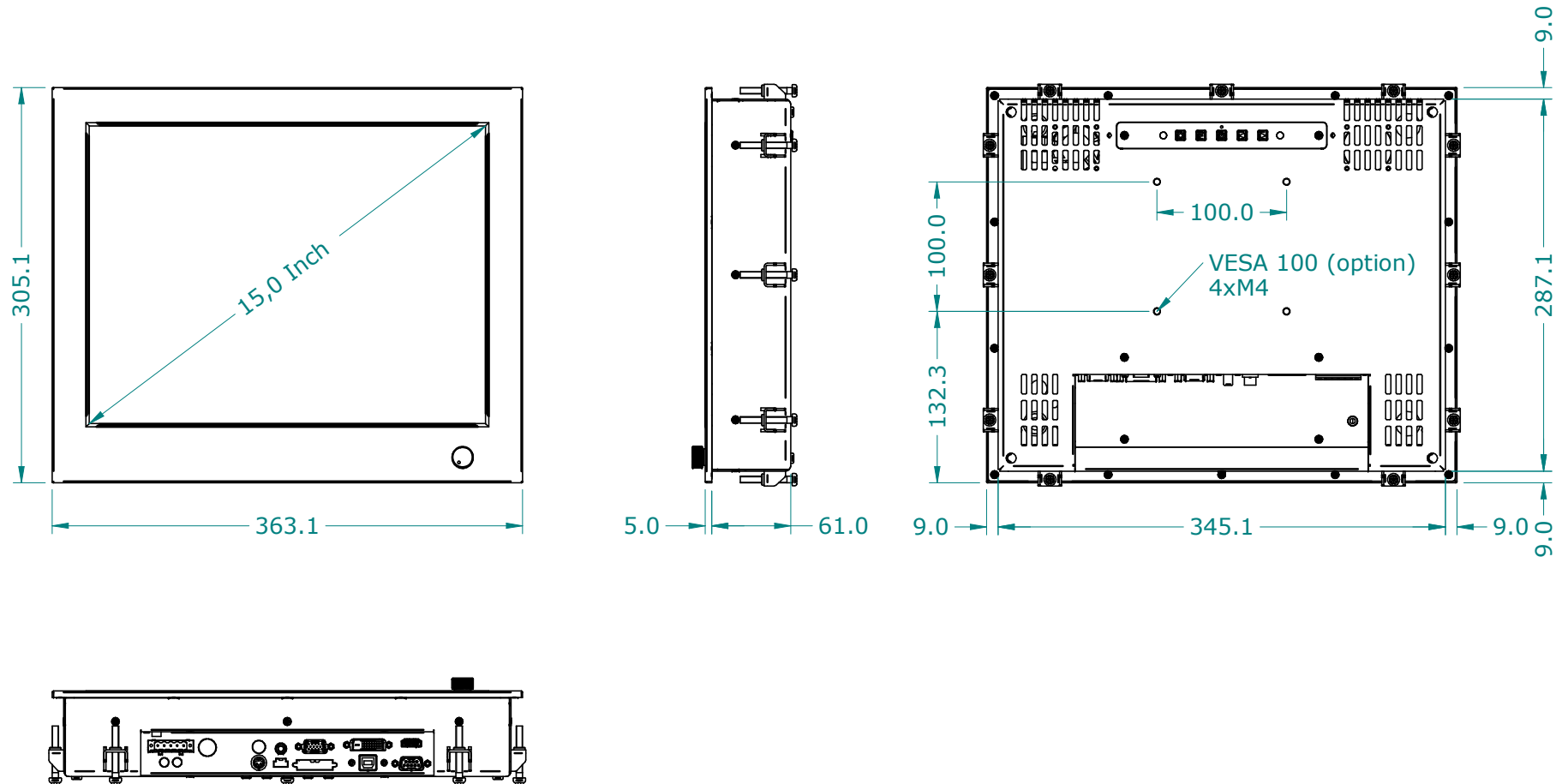

DIMENSIONS ARE SUBJECT TO CHANGE WITHOUT NOTICE

ISO 128  ALL DIMENSIONS ARE IN MILLIMETERS